

INSTRUCTIONS

FEMCO, Inc.

WEATHERBRAKE

307022174

FITS

431 & 461



General Offices
1132 W. 1ST STREET
McPherson, KS 67460
Phone: (620) 241-3513
Web: www.femcomfg.com

Form No. 286324300 / 11-2005

IMPORTANT

CAREFULLY STUDY THE PHOTO DIAGRAMS SHOWING THE LOCATION OF EACH PART. LEAVE ALL HARDWARE LOOSE UNTIL INSTRUCTED TO TIGHTEN.



YOKE BRACKET DASH

1. Remove bolts from side of dash.
2. Attach yoke bracket dash (A) to dash using four (4) M6 bolts.
3. Tighten bolts.

YOKE BRACKET

1. Attach yoke bracket (A) to top of yoke bracket dash using two (2) 1/4" x 3/4" bolts and nuts.
2. Tighten bolts.

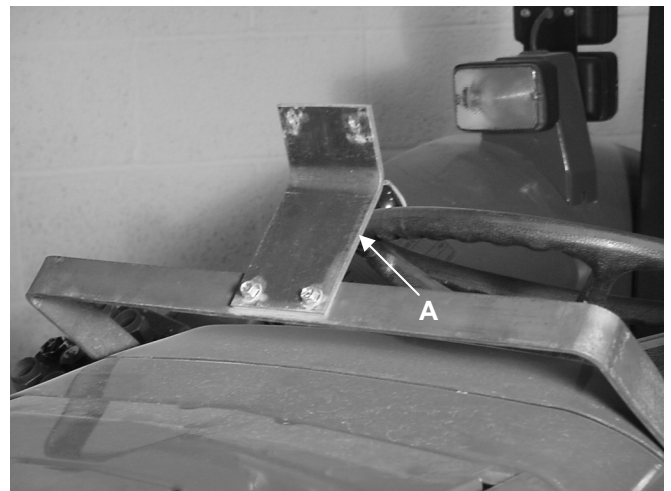

MUFFLER GUARD

1. Remove bolt A
2. Attach muffler guard (B) using same bolt removed.
3. Tighten bolt.

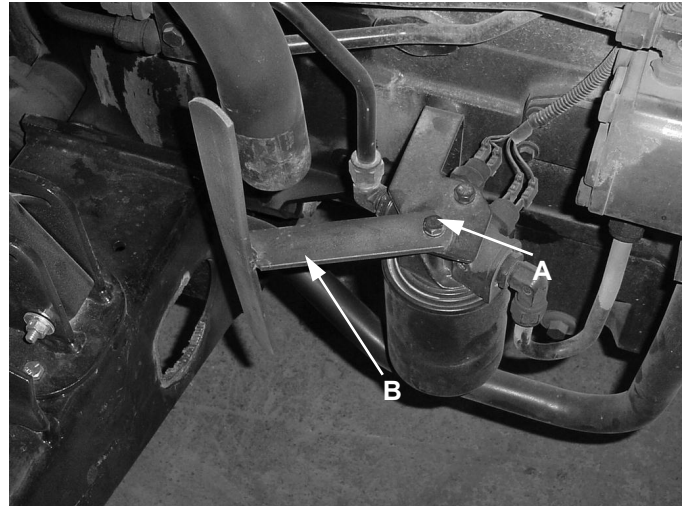

DOOR POST

1. Remove bolt from front of platform.
2. Attach door post (A) to platform using bolt removed.
3. Tighten bolts.

MOTOR COVER

1. Arrange motor cover over hood of tractor.
2. Slide 3" hem of motor cover down over top of door post.





YOKE

1. Insert yoke (A) into top 3" hem of motor cover.
2. Attach yoke to yoke bracket using two (2) 1/4" x 3/4" bolts and nuts
3. Attach yoke to door post using one (1) 1/4" x 1" bolt and nut. **Note:** Head of bolt inside, nut outside.

SIDE ARM

1. Slide side arm (A) into side 3" hem of motor cover.
2. Attach side arm to yoke using one (1) 3/8" x 1" bolt and nut. Head of bolt up, nut down.
3. Drill a 9/32" diameter hole in fender and attach rear of side arm using one (1) 1/4" x 1" bolt, fender washer and nut.
4. Tighten all bolts.

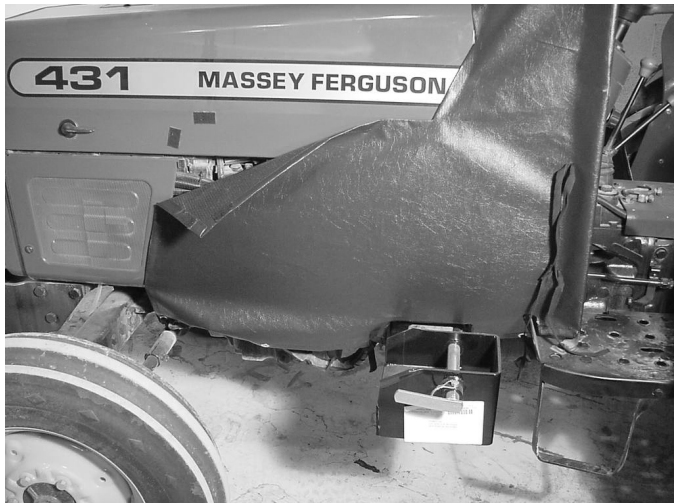

DUAL LOCK® is a registered trademark of the 3M Co.

1. Cut plastic Dual Lock® into 2" lengths.
2. Surface must be cleaned with a mild detergent to assure proper application of Dual Lock® strips.

NOTE: Do not peel the backing from the Dual Lock® .

3. Apply cut Dual Lock® to all Dual Lock® sewn to motor cover.
4. Arrange motor cover to tractor. Peel backing from Dual Lock® and apply to tractor. Repeat this procedure for all Dual Lock® .

TIE STRAPS

1. Thread cloth strap through grommets at bottom of motor cover and tie.
2. Route cloth straps to other side or to a point on tractor and tie.

IMPORTANT

Cloth straps are not to be attached to any moving, rotating, or heat generating points of tractor. Any excess cloth strap is to be cut off.

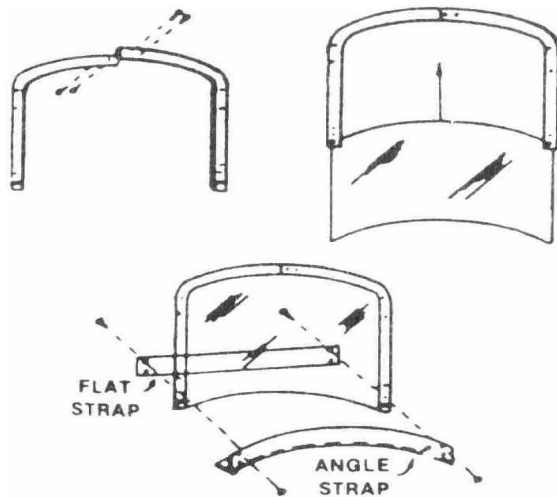
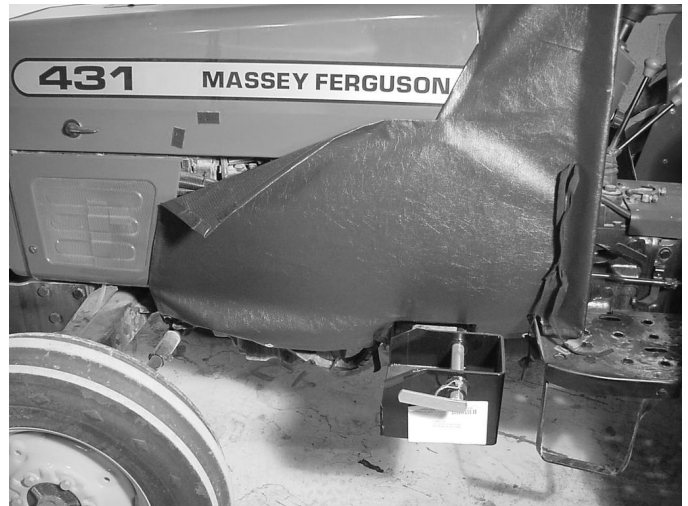

WINDSHIELD ASSEMBLY

1. Attach left and right window frames using two (2) #10 x 3/4" bolts and nuts.
2. Slide glass into the channel of the windshield.
3. Attach flat strip and angle strip to the windshield using two (2) #10 x 3/4" bolts and nuts.

WINDSHIELD ATTACHMENT

1. Remove nut from yoke and door post and attach assembled windshield.
2. Attach assembled windshield to outside of yoke with nut removed and 1/4" x 1" bolt and nut to other side of windshield.
3. Tighten all bolts.



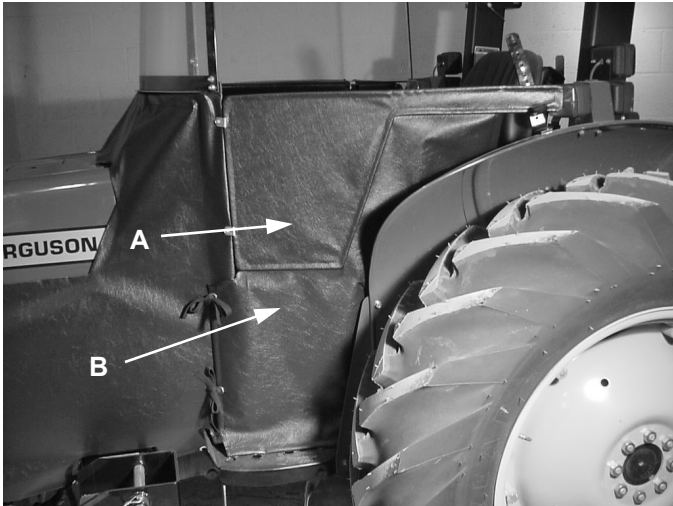

DOORS

1. Locate holes in door post and cut holes in the fabric.
2. Hold door (A) to door post and bottom of the windshield.
3. Mark location of holes in the door post to the door.
4. Cut 5/8" slots next to wire frame of door and attach to door post using four (4) #10 x 3/4" bolts, clips and nuts.
5. Tie door flap (B)
6. Tighten all bolts.

SIDE WINDOWS

1. Mark location of holes in windshield to side window (A).
2. Cut 5/8" slots next to wire frame of window and attach to windshield using #10 x 3/4" bolts, clips and nuts.
3. At location (B), cut 5/8" slots inside window and top of door and attach using #10 X 3/4" bolt, clip and nut.
4. Repeat procedure for other side.
5. Tighten all bolts.

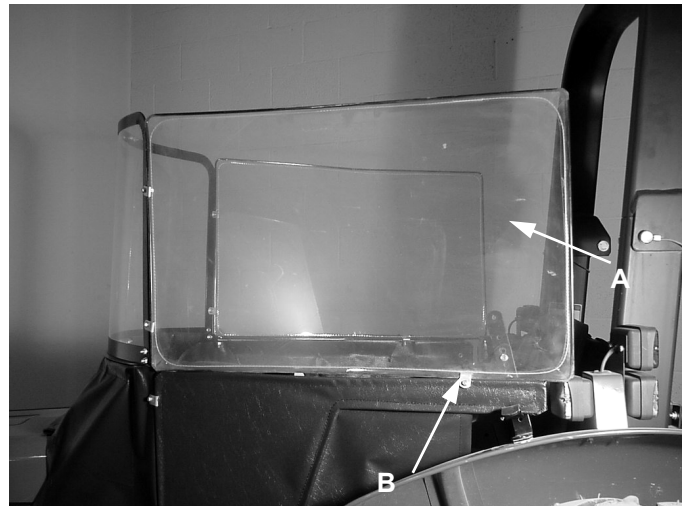

DOOR LATCH

1. Assemble door latches as shown using two (2) 1/4" x 3/4" bolts and nuts.
2. Position under bottom rear of door.
3. Door is to be set firmly in loop of door latch. Change position up or down with adjustment holes if necessary.
4. Mark location for one (1) of the two (2) holes and drill one (1) 9/32" diameter hole
5. Attach to fender using one (1) 1/4" x 1" bolt and nut.
6. Tighten all bolts.

NOTES